

Plain floor standing version 920



Plain 920 x 688
colour: Flat Black

Plain floor standing version 920



Connections:



Available sizes:



920 x 80
1 section (1)



920 x 278
3 sections (2+1)



920 x 360
4 sections (2+2)



920 x 442
5 sections (2+3)

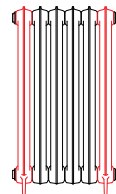

920 x 524
6 sections (2+4)



920 x 606
7 sections (2+5)

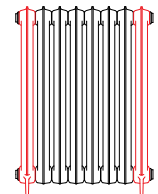

920 x 688
8 sections (2+6)

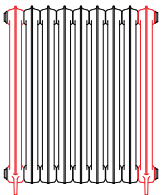

920 x 770
9 sections (2+7)

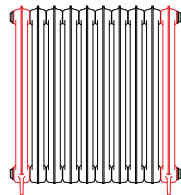

920 x 852
10 sections (2+8)

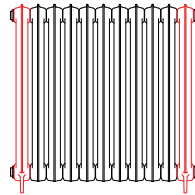

920 x 934
11 sections (2+9)

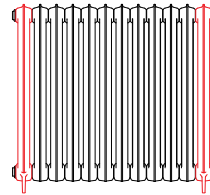

920 x 1016
12 sections (2+10)

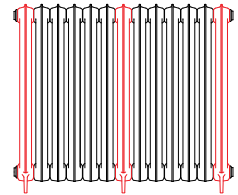

920 x 1098
13 sections (3+10)

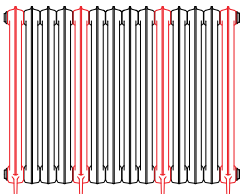

920 x 1180
14 sections (4+10)

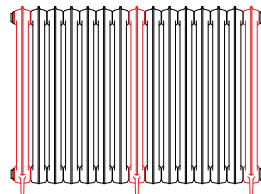

920 x 1262
15 sections (3+12)

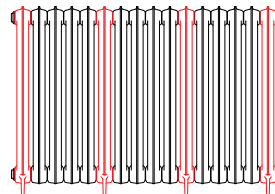

920 x 1344
16 sections (4+12)

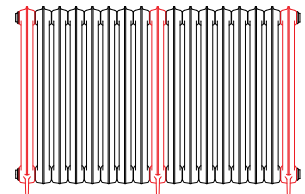

920 x 1426
17 sections (3+14)

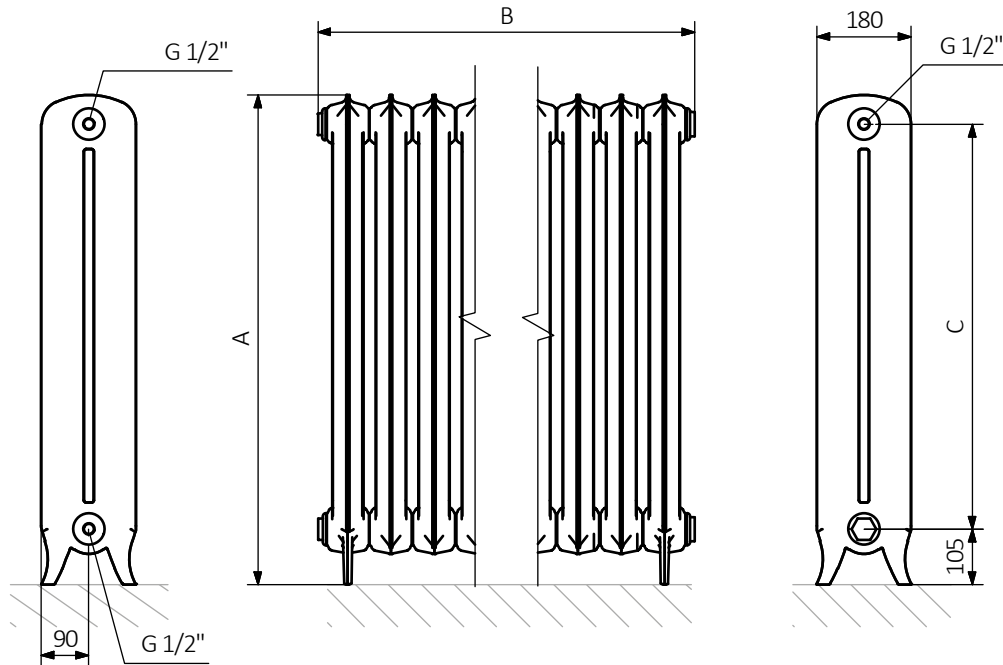

Plain floor standing version 920



A – Height B – Width C – Distance between pipe centres

Specifications:

Working pressure: 1000 kPa. Maximum operating temperature: 95°C.

A ↕	B ↔	C [mm]	75/65 20°C [W]	55/45 20°C [W]	 [dm ³]	 [kg]
920	80	760	161	85	4,14	12,5
920	278	760	483	256	12,42	37,8
920	360	760	644	341	16,56	49,5
920	442	760	805	426	20,70	61,2
920	524	760	966	511	24,84	72,9
920	606	760	1127	597	28,98	84,6
920	688	760	1288	682	33,12	96,3
920	770	760	1449	767	37,26	108,0
920	852	760	1610	852	41,40	119,7
920	934	760	1771	937	45,54	132,2
920	1016	760	1932	1023	49,68	144,7
920	1098	760	2093	1108	53,82	155,6
920	1180	760	2254	1193	57,96	168,1
920	1262	760	2415	1278	62,10	179,0
920	1344	760	2576	1364	66,24	191,5
920	1426	760	2737	1449	70,38	202,4