

Warp T Bold One

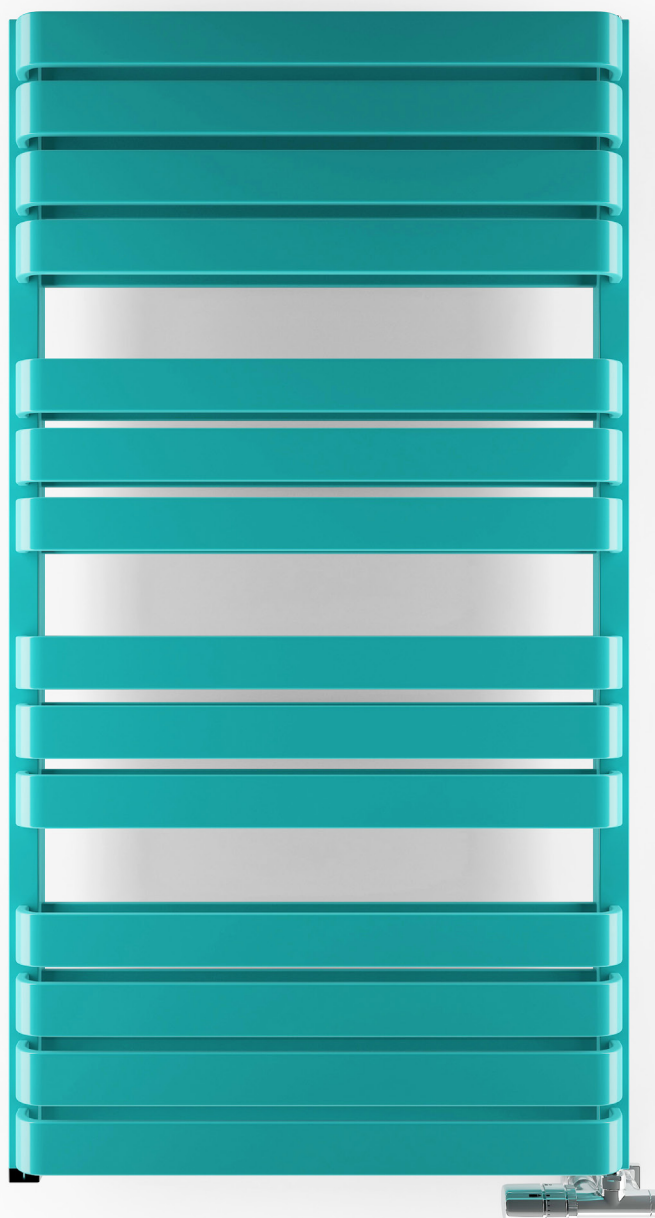

 colour included
in the price



Warp T Bold One 1110↓ × 500↔ S1
colour: RAL 5018

Angled integrated thermostatic valve set with immersion tube, right, chrome
Integrated pipe-masking set, chrome
ONE heating element



TERMA

SINCE 1990

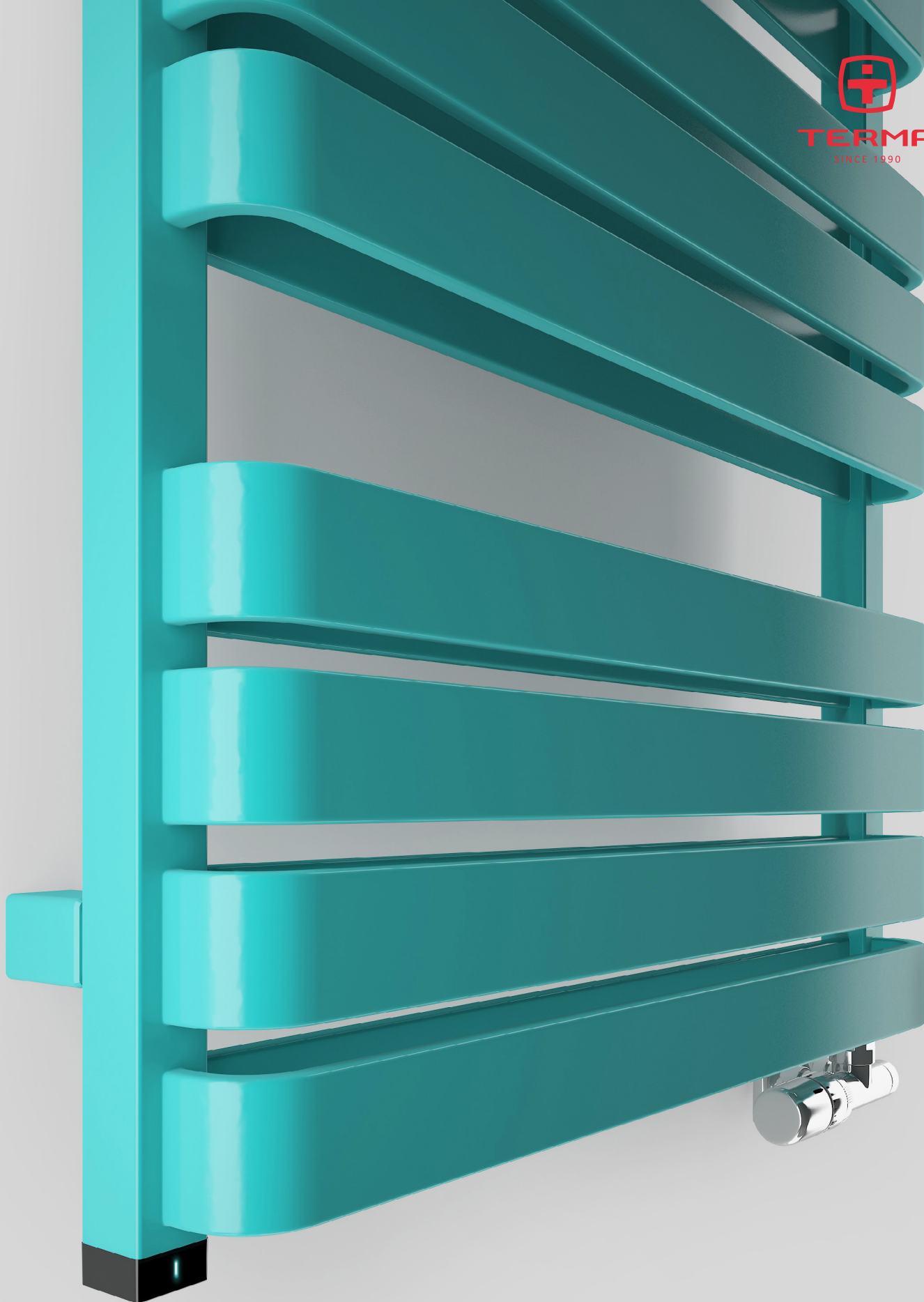

Warp T Bold One



colour included
in the price

Projekt : *Terma*

Standard connections:

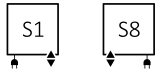

Electric radiators:

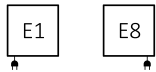

Technical drawing:

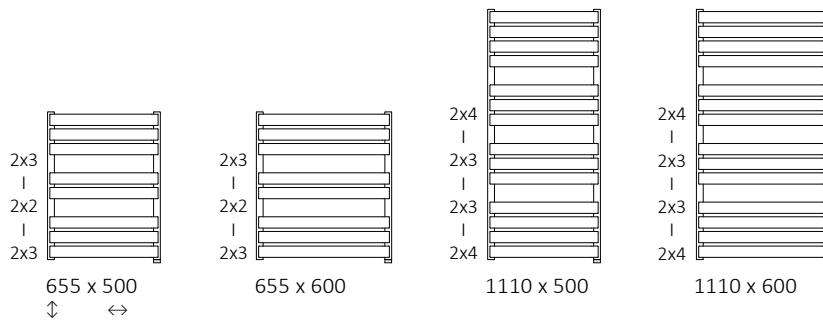

Specifications:

Working pressure: 600 kPa Maximum operating temperature: 82°C

A ↓ [mm]	B ↔ [mm]	75/65/20°C [W]	55/45/20°C [W]	⊕ [W]	D [mm]	E [mm]	F [mm]	⊞ [dm³]	⊞ [kg]	Product Code <small>configuration code p. 5</small>
655	500	460	249	400	470	515	70	3,48	12,40	WZWBN065050
655	600	545	294	600	570	515	70	4,00	14,56	WZWBN065060
1110	500	780	419	800	470	970	70	6,04	21,30	WZWBN111050
1110	600	924	491	1000	570	970	70	6,96	25,10	WZWBN111060

Warp T Bold One



colour included
in the price

S8

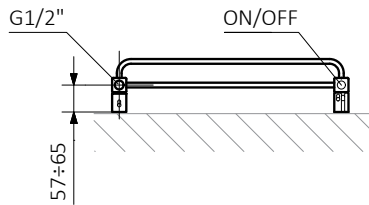

S1

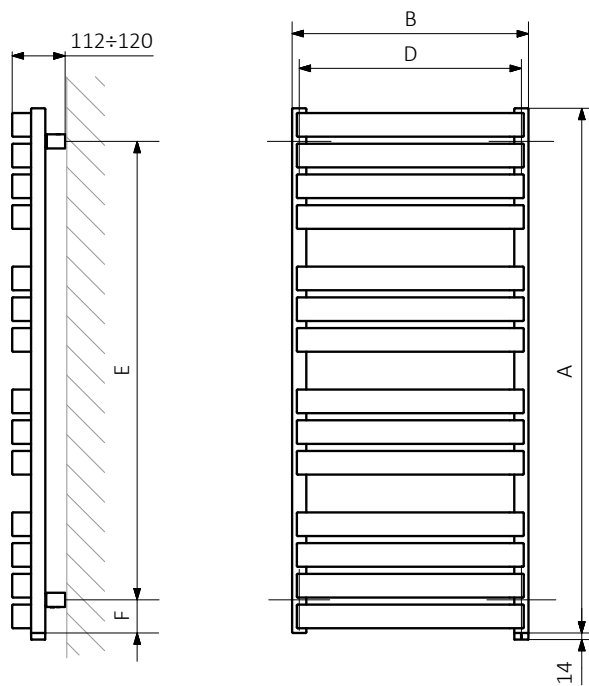
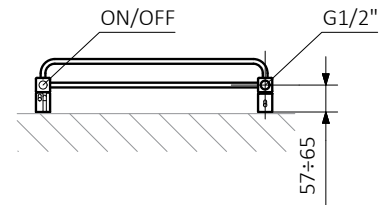

A – Height B – Width C1-C5 – Distance between pipe centres D – Horizontal distance between mounting bracket centres
E – Vertical distance between mounting brackets F – Distance between a mounting bracket and the bottom of the radiator

Collector :

Pipe :

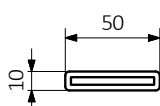
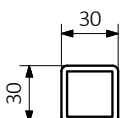

Warp T Bold One



colour included
in the price

In the table with technical data, the last column lists product codes. When placing an order, please remember to quote the product code followed by the configuration code as shown in the diagram below:

The construction of a configuration code of a water radiator with a built-in One heating element:

WZWBN065050

PRODUCT CODE
(located in the table for the product)

K916S1

CONIGURATION CODE
(supplemented by hand)

Cable Type

- W** – straight cable with plug
- P** – straight cable without plug
- U** – spiral cable with plug

Example Configuration

K 916 S1 P

Package code Plate color code Connection code Cable Type code
K - carton box

Epoxy primer

E – Code of epoxy primer is an extra processes.

WZWBN065050 K916S1 **E** — Extra processes or additions code

Warp T Bold One



Legend



Radiator available in a "water" version.



Radiator suitable for dual fuel connection. Electric heating element can be installed.



Radiator available in electric only version. It comes prefilled with a 'heating medium' and equipped with a heating element. All tested and ready to use.

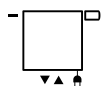

Connection types dedicated for this radiator. The icon shows the flow and return connections for the radiator as well as the thermostatic valve and heating element position if applicable.



Suggested heating element power output for electric and dual fuel versions.



Weight.



Capacity.



Available in chrome finish.



No additional payment for a color.